

ZVISLÉ - D

Z-D-6

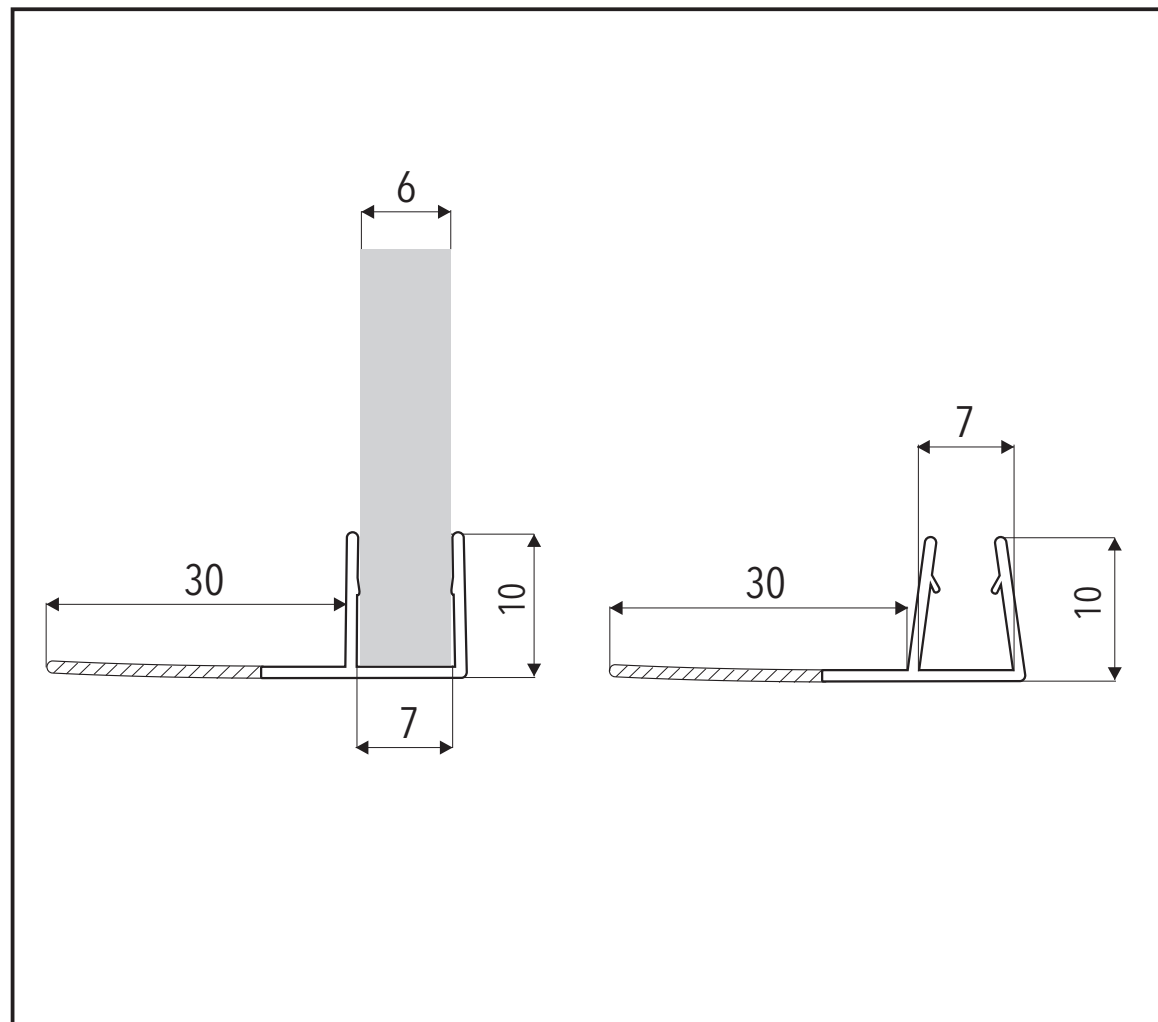

Názov	Dĺžka (mm)	Pre hr. skla (mm)	Cena s DPH
Z - D - 6	2000	6	19,80 € / ks

materiál : PVC Teplotný rozsah : 0 - 50°C UV odolnosť : EN ISO 4892-2